

How to use the psych package for regression and mediation analysis

William Revelle

March 18, 2024

Contents

1	Overview of this and related documents	3
1.1	Jump starting the <i>psych</i> package—a guide for the impatient	3
1.2	For the not impatient	4
2	Multiple regression and mediation	4
3	Regression using <code>lmCor</code>	5
3.1	Comparison with <code>lm</code> on complete data	5
3.1.1	It is important to know your data by describing it first	5
3.1.2	Now do the regressions	5
3.2	From a correlation matrix	6
3.3	The Hotelling example	9
3.4	Canonical Correlation using <code>lmCor</code>	10
3.5	Graphic displays	12
3.6	Moderated multiple regression	19
3.7	Plotting the interactions	20
3.8	Comparisons to <code>lm</code>	21
4	Mediation using the <code>mediate</code> function	23
4.1	Simple mediation	25
4.2	Multiple mediators	28
4.3	Serial mediators	28
4.4	Single mediators, multiple covariates	30
4.5	Single predictor, single criterion, multiple covariates	31
4.6	Multiple predictors, single criterion	33
5	Mediation and moderation	33

5.1	To center or not to center, that is the question	36
5.2	Another example of moderated mediation	40
5.3	Graphic Displays of Interactions	41
6	Partial Correlations	43
6.1	Partial some variables from the rest of the variables	44
6.2	Partial everything from everything	44
7	Related packages	45
8	Development version and a users guide	47
9	Psychometric Theory	47
10	SessionInfo	47

1 Overview of this and related documents

To do basic and advanced personality and psychological research using R is not as complicated as some think. This is one of a set of “How To” to do various things using R (R Core Team, 2023), particularly using the *psych* (Revelle, 2023) package.

The current list of How To’s includes:

1. An [introduction](#) (vignette) of the *psych* package
2. An [overview](#) (vignette) of the *psych* package
3. [Installing R](#) and some useful packages
4. Using R and the *psych* package to find ω_h and ω_t .
5. Using R and the *psych* for [factor analysis](#) and principal components analysis.
6. Using the `scoreItems` function to find [scale scores and scale statistics](#).
7. Using `mediate` and `lmCor` to do [mediation, moderation and regression analysis](#) (this document)

1.1 Jump starting the *psych* package—a guide for the impatient

You have installed *psych* and you want to use it without reading much more. What should you do?

1. Activate the *psych* and *psychTools* packages.

```
> library(psych)
> library(psychTools)
```

R code

2. Input your data. If your file name ends in `.sav`, `.text`, `.txt`, `.csv`, `.xpt`, `.rds`, `.Rds`, `.rda`, or `.RDATA`, then just read it in directly using `read.file`. Or you can go to your friendly text editor or data manipulation program (e.g., Excel) and copy the data to the clipboard. Include a first line that has the variable labels. Paste it into *psych* using the `read.clipboard.tab` command:

```
myData <- read.file() #this will open a search window on your machine
# and read or load the file.
#or
#first copy your file to your clipboard and then
myData <- read.clipboard.tab() #if you have an excel file
```

R code

3. Make sure that what you just read is right. Describe it and perhaps look at the first and last few lines. If you want to “view” the first and last few lines using a spreadsheet like viewer, use `quickView`.

R code

```
describe(myData)
headTail(myData)
#or
quickView(myData)
```

4. Look at the patterns in the data. If you have fewer than about 10 variables, look at the SPLOM (Scatter Plot Matrix) of the data using `pairs.panels`.

R code

```
pairs.panels(myData)
```

5. Find the correlations of all of your data.

- Descriptively (just the values)

R code

```
lowerCor(myData)
```

- Graphically

R code

```
corPlot(myData) #show the numbers,
                #scales the character size by "significance"
corPlot(myData, scale=FALSE) #show the numbers,
                              # all characters the same size
corPlot(lowerCor(myData), numbers =TRUE) #print the correlations
                                          # and show them graphically
```

1.2 For the not impatient

The following pages are meant to lead you through the use of the `lmCor` and `mediate` functions. The assumption is that you have already made *psych* active and want some example code.

2 Multiple regression and mediation

Mediation and moderation are merely different uses of the linear model $\hat{Y} = \mu + \beta_{y,x}X + \varepsilon$ and are implemented in *psych* with two functions: `lmCor` and `mediate`.

Given a set of predictor variables, X and a set of criteria variables, Y , multiple regression solves the equation $\hat{Y} = \mu + \beta_{y,x}X$ by finding $\beta_{y,x} = C_{xx}^{-1}C_{yx}$ where C_{xx} is the covariances of the X variables and C_{yx} is the covariances of predictors and the criteria.

Although typically done using the raw data, clearly this can also be done by using the covariance or correlation matrices. `lmCor` was developed to handle the correlation matrix solution but has been generalized to the case of raw data. In the later case, it assumes a Missing Completely at Random (MCAR) structure, and thus uses all the data and finds pair.wise complete correlations. For complete data sets, the results are identical to using `lm`. By default, `lmCor` uses standardized variables, but to compare with `lm`, it can use unstandardized variables.

3 Regression using lmCor

Although typically done from a raw data matrix (using the `lm` function), it is sometimes useful to do the regression from a correlation or covariance matrix. `lmCor` was developed for this purpose. From a correlation/covariance matrix, it will do normal regression as well as regression on partialled correlation matrices. With the raw data, it will also do moderated regression (centered or non-centered). In particular, for the raw data, it will work with missing data.

An interesting option, if using categorical or dichotomous data is first find the appropriate polychoric, tetrachoric, or poly-serial correlations using `mixedCor` and then use the resulting correlation matrix for analysis. The resulting correlations and multiple correlations will not match those of the `lm` analysis.

3.1 Comparison with lm on complete data

Use the `attitude` data set for our first example.

3.1.1 It is important to know your data by describing it first

```
> psych::describe(attitude)
```

	vars	n	mean	sd	median	trimmed	mad	min	max	range	skew	kurtosis	se
rating	1	30	64.63	12.17	65.5	65.21	10.38	40	85	45	-0.36	-0.77	2.22
complaints	2	30	66.60	13.31	65.0	67.08	14.83	37	90	53	-0.22	-0.68	2.43
privileges	3	30	53.13	12.24	51.5	52.75	10.38	30	83	53	0.38	-0.41	2.23
learning	4	30	56.37	11.74	56.5	56.58	14.83	34	75	41	-0.05	-1.22	2.14
raises	5	30	64.63	10.40	63.5	64.50	11.12	43	88	45	0.20	-0.60	1.90
critical	6	30	74.77	9.89	77.5	75.83	7.41	49	92	43	-0.87	0.17	1.81
advance	7	30	42.93	10.29	41.0	41.83	8.90	25	72	47	0.85	0.47	1.88

3.1.2 Now do the regressions

```
> #do not standardize
> mod1 <- lmCor(rating ~ complaints + privileges, data=attitude, std=FALSE)
> mod1
```

Call: `lmCor(y = rating ~ complaints + privileges, data = attitude, std = FALSE)`

Multiple Regression from raw data

DV = rating	slope	se	t	p	lower.ci	upper.ci	VIF	Vy.x
(Intercept)	15.33	7.16	2.14	4.1e-02	0.64	30.02	1.00	0.00
complaints	0.78	0.12	6.54	5.2e-07	0.54	1.03	1.45	0.70
privileges	-0.05	0.13	-0.39	7.0e-01	-0.32	0.22	1.45	-0.02

Residual Standard Error = 7.1 with 27 degrees of freedom

Multiple Regression

	R	R2	Ruw	R2uw	Shrunken R2	SE of R2	overall F	df1	df2	p
rating	0.83	0.68	0.62	0.38	0.66	0.08	29.1	2	27	1.83e-07

Compare this solution with the results of the `lm` function.

```
> summary(lm(rating ~ complaints + privileges, data=attitude))
```

```
Call:
lm(formula = rating ~ complaints + privileges, data = attitude)

Residuals:
    Min       1Q   Median       3Q      Max
-12.7887  -5.6893  -0.0284   6.2745   9.9726

Coefficients:
            Estimate Std. Error t value Pr(>|t|)
(Intercept) 15.32762    7.16023   2.141  0.0415 *
complaints   0.78034    0.11939   6.536 5.22e-07 ***
privileges  -0.05016    0.12992  -0.386  0.7025
---
Signif. codes:  0 '***' 0.001 '**' 0.01 '*' 0.05 '.' 0.1 ' ' 1

Residual standard error: 7.102 on 27 degrees of freedom
Multiple R-squared:  0.6831,    Adjusted R-squared:  0.6596
F-statistic: 29.1 on 2 and 27 DF,  p-value: 1.833e-07
```

The graphic for the standardized regression is shown in (Figure 1).

```
Call: lmCor(y = rating ~ complaints + privileges, data = attitude)

Multiple Regression from raw data

DV = rating
      slope se      t      p lower.ci upper.ci VIF  Vy.x
(Intercept) 0.00 0.11  0.00 1.0e+00  -0.22  0.22 1.00  0.00
complaints  0.85 0.13  6.54 5.2e-07   0.59  1.12 1.45  0.70
privileges -0.05 0.13 -0.39 7.0e-01  -0.32  0.22 1.45 -0.02

Residual Standard Error = 0.58 with 27 degrees of freedom

Multiple Regression
      R  R2  Ruw R2uw Shrunken R2 SE of R2 overall F df1 df2      p
rating 0.83 0.68 0.71 0.5      0.66  0.08  29.1  2  27 1.83e-07

pdf
2
```

3.2 From a correlation matrix

Perhaps most usefully, `lmCor` will find the beta weights between a set of X variables, and a set of Y variables. Consider seven variables in the `attitude` data set. We first find the correlation matrix (normally, this could just be supplied by the user). Then we find the regressions from the correlation matrix. Compare this regression to the (standardized) solution shown above. By specifying the number of observations (`n.obs`), we are able to apply various inferential tests.

A simple regression model

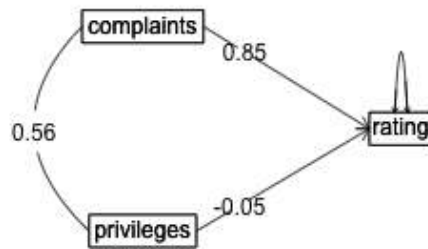

Figure 1: A simple multiple regression using the attitude data set (standardized solution is shown).

R code

```
> R <- lowerCor(attitude)
```

```
          ratng  cmpln  prvlg  lrnng  raiss  crtcl  advnc
rating      1.00
complaints  0.83   1.00
privileges  0.43   0.56   1.00
learning    0.62   0.60   0.49   1.00
raises      0.59   0.67   0.45   0.64   1.00
critical    0.16   0.19   0.15   0.12   0.38   1.00
advance     0.16   0.22   0.34   0.53   0.57   0.28   1.00
```

R code

```
> lmCor(rating ~ complaints + privileges, data=R, n.obs =30)
```

Call: `lmCor(y = rating ~ complaints + privileges, data = R, n.obs = 30)`

Multiple Regression from matrix input

```
DV = rating
      slope  se      t      p lower.ci upper.ci VIF  Vy.x
complaints  0.85 0.13  6.54 5.2e-07  0.59  1.12 1.45  0.70
privileges -0.05 0.13 -0.39 7.0e-01 -0.32  0.22 1.45 -0.02
```

Residual Standard Error = 0.58 with 27 degrees of freedom

```
Multiple Regression
      R  R2  Row  R2uw  Shrunken R2  SE of R2  overall F  df1  df2      p
rating 0.83 0.68 0.71 0.5  0.66  0.08  29.1  2  27 1.83e-07
```

Compare this solution (from the correlation matrix) with the *standardized* solution for the raw data. `lmCor` does several things:

- Finds the regression weights (betas) between the predictor variables and each of the criterion variables.
- If the number of subjects is specified, or if the raw data are used, it also compares each of these betas to its standard error, finds a t statistic, and reports the probability of the $|t| > 0$.
- It reports the Multiple R and R^2 based upon these beta weights. In addition, following the tradition of the robust beauty of the improper linear models (Dawes, 1979) it also reports the unit weighted multiple correlations.
- If there are more than 1 Y variables, the canonical correlations between the two sets (X and Y) (Hotelling, 1936) are reported. The canonical loadings are reported in the Xmat and Ymat objects.
- Cohen's set correlation (Cohen, 1982) as well as the unweighted correlation between the two sets of variables are reported.

3.3 The Hotelling example

R code

```
> #the second Kelley data from Hotelling
> kelley <- structure(list(speed = c(1, 0.4248, 0.042, 0.0215, 0.0573), power = c(0.4248,
+ 1, 0.1487, 0.2489, 0.2843), words = c(0.042, 0.1487, 1, 0.6693,
+ 0.4662), symbols = c(0.0215, 0.2489, 0.6693, 1, 0.6915), meaningless = c(0.0573,
+ 0.2843, 0.4662, 0.6915, 1)), .Names = c("speed", "power", "words",
+ "symbols", "meaningless"), class = "data.frame", row.names = c("speed",
+ "power", "words", "symbols", "meaningless"))
> #first show the correlations
> lowerMat(kelley)
```

```
           speed power words syml mngl
speed      1.00
power      0.42  1.00
words      0.04  0.15  1.00
symbols    0.02  0.25  0.67  1.00
meaningless 0.06  0.28  0.47  0.69  1.00
```

R code

```
> #now find and draw the regression
> sc <- lmCor(power + speed ~ words + symbols + meaningless,data=kelley) #formula mode
> sc #show it
```

Call: `lmCor(y = power + speed ~ words + symbols + meaningless, data = kelley)`

Multiple Regression from matrix input

```
DV = power
      slope VIF Vy.x
words  -0.03 1.81 -0.01
symbols  0.12 2.72  0.03
meaningless 0.22 1.92  0.06
```

```
Multiple Regression
      R R2 Ruw R2uw
power 0.29 0.09 0.26 0.07
```

```
DV = speed
      slope VIF Vy.x
words  0.05 1.81  0
symbols -0.07 2.72  0
meaningless 0.08 1.92  0
```

```
Multiple Regression
      R R2 Ruw R2uw
speed 0.07 0.01 0.05  0
```

Various estimates of between set correlations

Squared Canonical Correlations

```
[1] 0.1036 0.0032
```

```
Average squared canonical correlation = 0.05
Cohen's Set Correlation R2 = 0.1
Unweighted correlation between the two sets = 0.18
```

A plot of the regression model is shown as well (Figure 2).

The Kelley data set

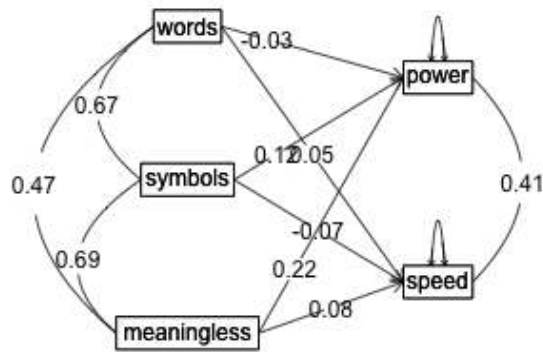

Figure 2: The relationship between three predictors and two criteria from `lmCor`. The data are from the Kelley data set reported by [Hotelling \(1936\)](#).

3.4 Canonical Correlation using `lmCor`

A generalization of multiple regression to multiple predictors and multiple criteria is *canonical correlation* ([Hotelling, 1936](#)). Given a partitioning of a correlation matrix, R , into R_{xx} , R_{yy} and R_{xy} , canonical correlation finds orthogonal components of the correlations between the R_x and R_y sets (the R_{xy} correlations). Consider the Kelley data set discussed by [Hotelling \(1936\)](#) who introduced the canonical correlation. This analysis is shown in help menu for `lmCor`. Another data set is the “Belly Dancer” data set discussed by [Tabachnick and Fidell \(2001\)](#) (Chapter 12). Here I show the data, the correlations, the regressions, and the canonical correlations.

R code

```
> dancer <- structure(list(TS = c(1, 7, 4.6, 1, 7, 7, 7, 7), TC = c(1, 1,
+ 5.6, 6.6, 4.9, 7, 1, 1), BS = c(1, 7, 7, 1, 7, 6.4, 7, 2.4),
+ BC = c(1, 1, 7, 5.9, 2.9, 3.8, 1, 1)), class = "data.frame", row.names = c(NA,
+ -8L))
> dancer #show the data
```

```
   TS TC BS BC
1  1.0 1.0 1.0 1.0
2  7.0 1.0 7.0 1.0
3  4.6 5.6 7.0 7.0
4  1.0 6.6 1.0 5.9
5  7.0 4.9 7.0 2.9
6  7.0 7.0 6.4 3.8
7  7.0 1.0 7.0 1.0
8  7.0 1.0 2.4 1.0
```

R code

```
> model <- psych::lmCor(TC + TS ~ BC + BS, data = dancer)
> summary(model) #show the summary statistics
```

Multiple Regression from raw data
psych::lmCor(y = TC + TS ~ BC + BS, data = dancer)

Multiple Regression from matrix input

Beta weights

	TC	TS
(Intercept)	0.000	0.00
BC	0.854	-0.38
BS	0.066	0.78

Multiple R

TC	TS
0.86	0.85

Multiple R2

TC	TS
0.74	0.72

Cohen's set correlation R2

[1] 0.93

Squared Canonical Correlations

[1] 0.84 0.58

R code

```
> round(model$Xmat, 2) #the X canonical loadings
```

	Cx1	Cx2
BC	-0.88	0.48
BS	0.44	0.90

R code

```
> round(model$Ymat, 2) #the Y canonical loadings
```

	Cy1	Cy2
TC	-0.79	0.62
TS	0.74	0.68

R code

```
> cancorDiagram(model, main="Canonical correlations for the 'Belly Dancer' example") #and the associated can
>
```

But, we can also do multiple predictors *and* multiple criteria in the same call:

```
pdf
2
```

3.5 Graphic displays

When considering the within group relationships for multiple groups, (e.g., gender or grade level) it is useful to draw separate regression lines for each group. Consider the case of the regression of age on paragraph comprehension as a function of class grade (6 or 7) in the `holzinger.swineford` data set in *psychTools*.

R code

```
> lowerCor(holzinger.swineford[c(3,7,12:14)])
```

	grade	agemo	t05_g	t06_p	t07_s
grade	1.00				
agemo	0.53	1.00			
t05_geninfo	0.21	-0.15	1.00		
t06_paracomp	0.21	-0.20	0.66	1.00	
t07_sentcomp	0.18	-0.23	0.72	0.73	1.00

It would seem as if both age and grade account for 4% of the variance in paragraph comprehension. But combining these two in a multiple regression increases the variance explained from 8% (the sum of the two) to 18%, because age and grade suppress variance unrelated to cognitive performance.

Show this finding in two different ways: as a plot of the separate regression lines Figure 6 for each grade or as a simple path model Figure 7. Note that because grade goes from 7 to 8, to index the colors in the plot we subtract 6 from both grades to get a 1, 2 variable.

R code

```
> png('hs.png')
> plot(t07_sentcomp ~ agemo, col=c("red", "blue")[holzinger.swineford$grade -6],
+      pch=26-holzinger.swineford$grade, data=holzinger.swineford,
+      ylab="Sentence Comprehension", xlab="Age in Months",
+      main="Sentence Comprehension varies by age and grade")
> by(holzinger.swineford, holzinger.swineford$grade -6, function(x) abline(
+      lmCor(t07_sentcomp ~ agemo, data=x, std=FALSE, plot=FALSE), lty=c("dashed", "solid")[x$grade-6]))
```

```
holzinger.swineford$grade - 6: 1
NULL
```

```
-----
holzinger.swineford$grade - 6: 2
NULL
```

R code

```
> text(190, 3.3, "grade = 8")
> text(190, 2, "grade = 7")
> dev.off()
```

R code

```
> png('dancerlm.png')  
> model <- psych::lmCor(TC + TS ~ BC + BS, data = dancer)  
> dev.off()
```

pdf
2

Regression Models

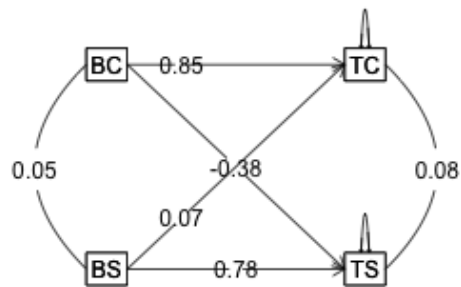

Figure 3: Multiple regression of the Belly Dancer data set. Compare with the canonical correlation figure 4

R code

```
> png('dancer.png')  
> cancorDiagram(model)  
> dev.off()
```

pdf
2

Canonical Correlation

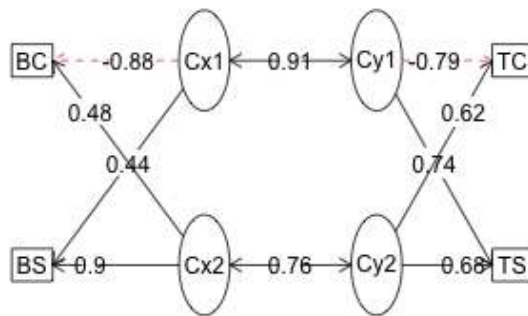

Figure 4: Canonical Correlation of the Belly Dancer data set. Compare with the linear regression figure 3

Regression Models

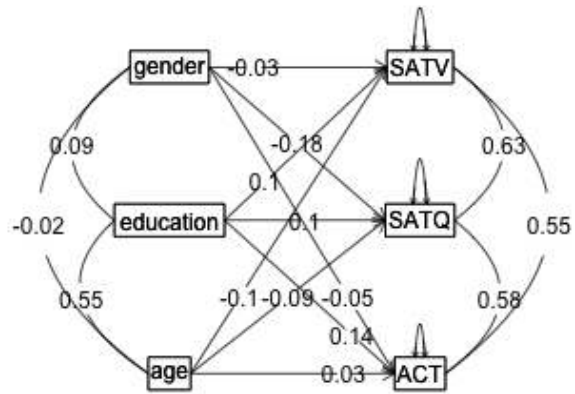

Figure 5: The relationship between three predictors and three criteria from `lmCor`. The data are from the `sat.act` data set.

To show just the coefficients of this model, do the regressions without the plot, turn off the plot option:

```
R code  
> by(holzinger.swineford,holzinger.swineford$grade,function(x)  
+     lmCor(t07_sentcomp ~ agemo,data=x, std=FALSE, plot=FALSE) )
```

```
holzinger.swineford$grade: 7  
Call: lmCor(y = t07_sentcomp ~ agemo, data = x, std = FALSE, plot = FALSE)
```

Multiple Regression from raw data

```
DV = t07_sentcomp  
      slope se      t      p lower.ci upper.ci VIF Vy.x  
(Intercept) 12.10 1.37  8.83 2.1e-15    9.39   14.81   1 0.00  
agemo        -0.05 0.01 -5.83 3.0e-08   -0.07   -0.03   1 0.18
```

Residual Standard Error = 1.15 with 155 degrees of freedom

```
Multiple Regression  
      R  R2  Ruw R2uw Shrunken R2 SE of R2 overall F df1 df2      p  
t07_sentcomp 0.42 0.18 -0.3 0.09      0.17   0.05    34.04   1 155 3.05e-08
```

```
holzinger.swineford$grade: 8  
Call: lmCor(y = t07_sentcomp ~ agemo, data = x, std = FALSE, plot = FALSE)
```

Multiple Regression from raw data

```
DV = t07_sentcomp  
      slope se      t      p lower.ci upper.ci VIF Vy.x  
(Intercept) 12.09 1.64  7.38 1.2e-11    8.85   15.33   1 0.00  
agemo        -0.04 0.01 -4.59 9.5e-06   -0.06   -0.03   1 0.13
```

Residual Standard Error = 1.2 with 142 degrees of freedom

```
Multiple Regression  
      R  R2  Ruw R2uw Shrunken R2 SE of R2 overall F df1 df2      p  
t07_sentcomp 0.36 0.13 -0.25 0.06      0.12   0.05    21.11   1 142 9.5e-06
```

```
R code  
> png('hsp.png')  
> lmCor(t07_sentcomp ~ agemo + grade,data=holzinger.swineford)
```

```
Call: lmCor(y = t07_sentcomp ~ agemo + grade, data = holzinger.swineford)
```

Multiple Regression from raw data

```
DV = t07_sentcomp  
      slope se      t      p lower.ci upper.ci VIF Vy.x  
(Intercept) 0.00 0.05  0.00 1.0e+00   -0.10   0.10 1.00 0.00  
agemo       -0.46 0.06 -7.39 1.5e-12   -0.58   -0.34 1.39 0.11  
grade        0.42 0.06  6.78 6.4e-11    0.30   0.54 1.39 0.07
```

Residual Standard Error = 0.91 with 298 degrees of freedom

Multiple Regression

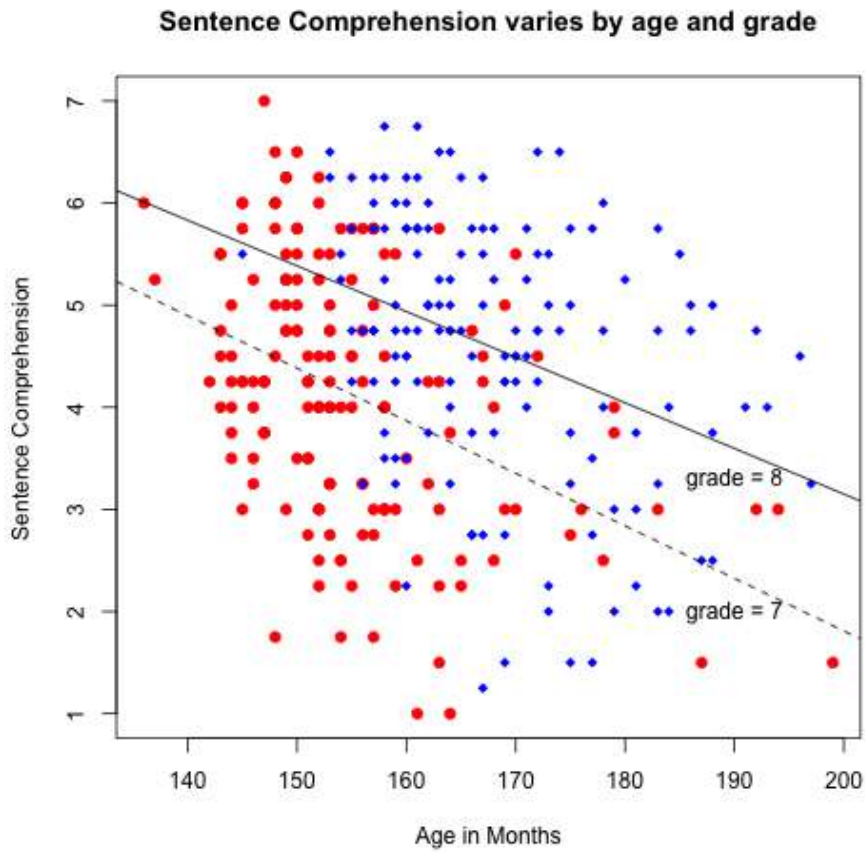

Figure 6: Showing a multiple regression using `lmCor` with lines for each group. The data are from the `holzinger:swineford` data set. Although age and grade are highly correlated (.53) grade has a positive effect age a negative effect.

	R	R2	Ruw	R2uw	Shrunken R2	SE of R2	overall F	df1	df2	p
t07_sentcomp	0.43	0.18	0.42	0.18	0.18	0.04	32.97	2	298	1.16e-13

```
> dev.off()
```

pdf
2

Regression Models

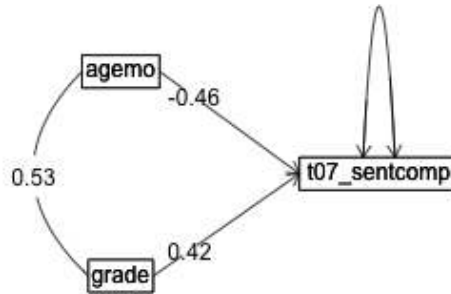

Figure 7: The regression of age and grade on paragraph comprehension. The data are from the `holzinger:swineford` data set. Although age and grade are highly correlated (.53) grade has a positive effect age a negative effect. Here we show the standardized regressions. In the subsequent figure we show the raw (understanderized) slopes.

3.6 Moderated multiple regression

With the raw data, find interactions (known as moderated multiple regression). This is done by zero centering the data (Cohen et al., 2003) and then multiplying the two terms of the interaction. As an option, do not zero center the data (Hayes, 2013) which results in different “main effects” but the same interaction term. To show the equivalence of the interaction terms, we also must not standardize the results.

Use the `globalWarm` data set taken from (Hayes, 2013)

```
R code
> mod <-lmCor(govact ~ negemot * age + posemot +ideology+sex,data=globalWarm,
+             std=FALSE, zero=FALSE, plot=FALSE)
> mod
```

```
Call: lmCor(y = govact ~ negemot * age + posemot + ideology + sex,
            data = globalWarm, std = FALSE, plot = FALSE, zero = FALSE)
```

Multiple Regression from raw data

```
DV = govact
```

	slope	se	t	p	lower.ci	upper.ci	VIF	Vy.x
(Intercept)	5.17	0.34	15.29	1.6e-46	4.51	5.84	1.00	0.00
negemot	0.12	0.08	1.45	1.5e-01	-0.04	0.28	11.59	0.08
age	-0.02	0.01	-3.99	7.1e-05	-0.04	-0.01	6.95	0.03
posemot	-0.02	0.03	-0.77	4.4e-01	-0.08	0.03	1.03	0.00
ideology	-0.21	0.03	-7.88	1.0e-14	-0.26	-0.16	1.20	0.10
sex	-0.01	0.08	-0.15	8.8e-01	-0.16	0.14	1.05	0.00
negemot*age	0.01	0.00	4.10	4.5e-05	0.00	0.01	16.46	0.20

Residual Standard Error = 1.06 with 808 degrees of freedom

```
Multiple Regression
```

	R	R2	Ruw	R2uw	Shrunken R2	SE of R2	overall F	df1	df2	p
govact	0.63	0.4	0.14	0.02	0.4	0.03	90.08	6	808	1.82e-86

```
R code
> mod0 <- lmCor(govact ~ negemot * age + posemot +ideology+sex,data=globalWarm,std=FALSE, plot=FALSE)
> mod0
```

```
Call: lmCor(y = govact ~ negemot * age + posemot + ideology + sex,
            data = globalWarm, std = FALSE, plot = FALSE)
```

Multiple Regression from raw data

```
DV = govact
```

	slope	se	t	p	lower.ci	upper.ci	VIF	Vy.x
(Intercept)	4.60	0.04	123.92	0.0e+00	4.52	4.67	1.00	0.00
negemot	0.43	0.03	16.51	5.8e-53	0.38	0.48	1.17	0.28
age	0.00	0.00	-0.58	5.6e-01	-0.01	0.00	1.07	0.00
posemot	-0.02	0.03	-0.77	4.4e-01	-0.08	0.03	1.03	0.00
ideology	-0.21	0.03	-7.88	1.0e-14	-0.26	-0.16	1.20	0.10
sex	-0.01	0.08	-0.15	8.8e-01	-0.16	0.14	1.05	0.00
negemot*age	0.01	0.00	4.10	4.5e-05	0.00	0.01	1.01	0.02

Residual Standard Error = 1.06 with 808 degrees of freedom

```

Multiple Regression
      R  R2  Ruv  R2uw  Shrunken  R2  SE of R2  overall  F  df1  df2      p
govact 0.63 0.4 0.36 0.13          0.4    0.03    90.08    6 808 1.82e-86

```

```
pdf
2
```

```
pdf
2
```

not zero centered

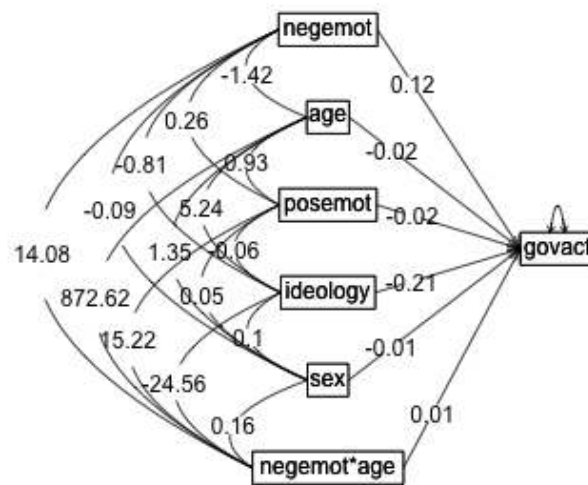

Figure 8: Showing a moderated multiple regression using `lmCor`. The data are from the `globalWarm` data set.

3.7 Plotting the interactions

To visualize the effect of zero (mean) centering, it is useful to plot the various elements that go into the linear model. `lmCor` returns the product terms as well as the original data. Combine the two datasets to make it clearer. Note that the correlations of the centered age, negemot with the

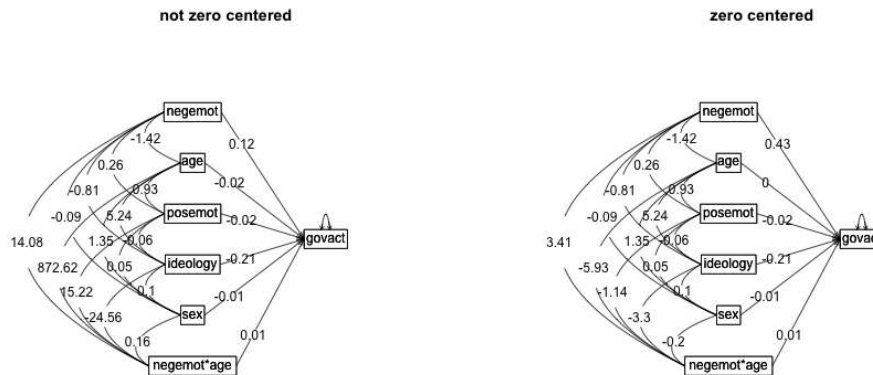

Figure 9: The difference between 0 and not 0 centering `lmCor`. The data are from the `globalWarm` data set. In both cases, the data are not standardized.

uncentered are 1.0, but that the correlations with the product terms depend upon centering versus not. Drop some of the other variables from the figure for clarity (Figure 10).

pdf
2

3.8 Comparisons to `lm`

The `lmCor` function duplicates the functionality of the `lm` function for complete data, although `lm` does not zero center and `lmCor` will (by default). In addition, `lmCor` finds correlations based upon pair.wise deletion of missing data, while `lm` does case.wise deletion. We compare the `lm` and `lmCor` results for complete data by setting the `use = "complete"` option. Use the `sat.act` data set which has some missing values.

```
> summary(lm(SATQ ~ SATV*gender + ACT, data=sat.act))
```

Call:
lm(formula = SATQ ~ SATV * gender + ACT, data = sat.act)

Residuals:
Min 1Q Median 3Q Max
-296.210 -45.738 4.323 52.355 252.306

Coefficients:
Estimate Std. Error t value Pr(>|t|)
(Intercept) 138.52395 61.18770 2.264 0.0239 *
SATV 0.50280 0.10030 5.013 6.84e-07 ***

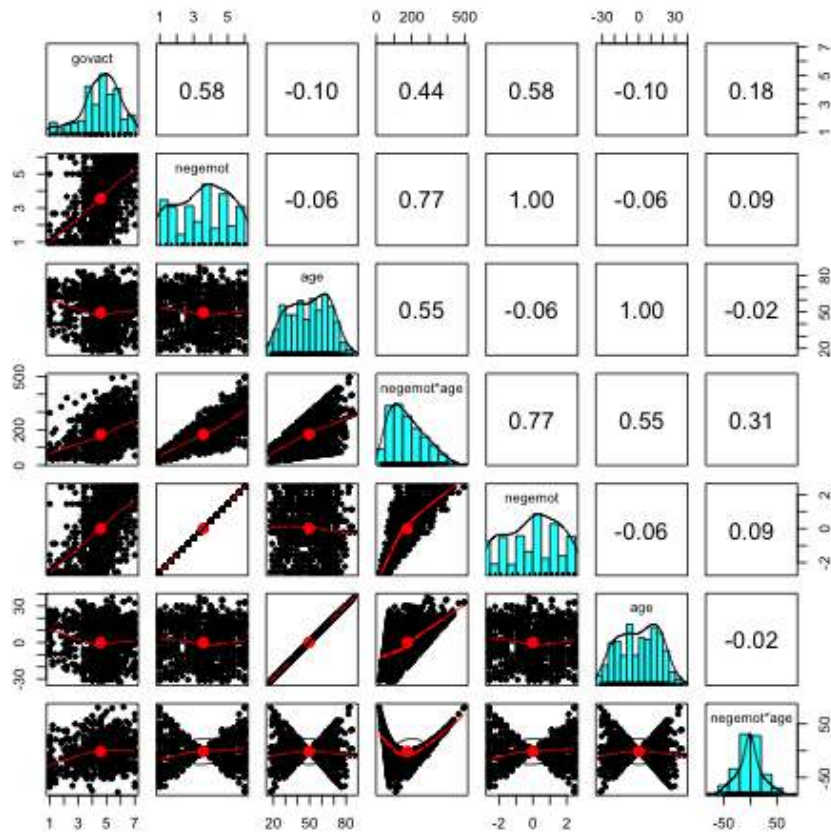

Figure 10: The effect of not mean centering versus mean centering on the product terms. The first four variables were not zero centered, the second four were.

```

gender      -22.24995   35.59228  -0.625   0.5321
ACT         7.71702     0.77707   9.931 < 2e-16 ***
SATV:gender -0.01984     0.05706  -0.348   0.7281
---
Signif. codes:  0 '***' 0.001 '**' 0.01 '*' 0.05 '.' 0.1 ' ' 1

Residual standard error: 81.18 on 682 degrees of freedom
(13 observations deleted due to missingness)
Multiple R-squared:  0.51,    Adjusted R-squared:  0.5071
F-statistic: 177.5 on 4 and 682 DF,  p-value: < 2.2e-16

```

```

R code
> mod <- lmCor(SATQ ~ SATV*gender + ACT, data=(sat.act), zero=FALSE, std=FALSE, use="complete")
> print(mod, digits=5)

```

```

Call: lmCor(y = SATQ ~ SATV * gender + ACT, data = (sat.act), use = "complete",
           std = FALSE, zero = FALSE)

Multiple Regression from raw data

DV = SATQ

      slope      se      t      p  lower.ci  upper.ci      VIF      Vy.x
(Intercept) 138.52395 61.18770 2.26392 2.3892e-02 18.38505 258.66284 1.00000 0.00000
SATV         0.50280  0.10030 5.01295 6.8399e-07  0.30587  0.69973 13.43994 0.31739
gender      -22.24995 35.59228 -0.62513 5.3209e-01 -92.13355 47.63365 30.29663 0.01525
ACT         7.71702  0.77707 9.93090 8.4691e-22  6.19128  9.24276 1.46678 0.18928
SATV*gender -0.01984  0.05706 -0.34775 7.2814e-01 -0.13188  0.09219 41.25607 -0.01191

Residual Standard Error = 81.18474 with 682 degrees of freedom

Multiple Regression
      R    R2    Ruw    R2uw Shrunken R2 SE of R2 overall F df1 df2      p
SATQ 0.71414 0.51 0.41706 0.17394 0.50712 0.02645 177.4575 4 682 3.98472e-104

```

4 Mediation using the mediate function

Mediation analysis is just linear regression reorganized slightly to show the direct effects of an X variable upon Y, partialling out the effect of a “mediator” (Figure 11). Although the statistical “significance” of the (c) path and the (c’) path are both available from standard regression, the mediation effect (ab) is best found by bootstrapping the regression model and displaying the empirical confidence intervals.

A number of papers discuss how to test for the effect of mediation and there are some very popular ‘macros’ for SPSS and SAS to do so (Hayes, 2013; Preacher and Hayes, 2004; Preacher et al., 2007; Preacher, 2015). A useful discussion of mediation and moderation with sample data sets is found in Hayes (2013). More recently, the *processR* package (Moon, 2020) has been released with these data sets. Although these data used to be available from <http://www.afhayes.com/public/hayes2018data.zip> this now longer seems to be case.¹ I use these for comparisons with the results in Hayes (2013). Four of these data sets are now included in the *psych* package with the kind permission of their

¹The Hayes data sets (2018) do not correspond exactly with those from the 2013 book. Those data files were at <http://www.afhayes.com/public/hayes2013data.zip>.

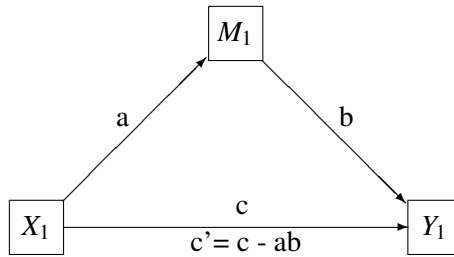

Figure 11: The classic mediation model. The Direct Path from X \rightarrow Y (c) is said to be mediated by the indirect path (a) to the mediator (X \rightarrow M) and (b) from the mediator to Y (M \rightarrow Y). The mediation effect is (ab).

authors: Garcia is from [Garcia et al. \(2010\)](#), and Tal_Or is from [Tal-Or et al. \(2010\)](#), The Pollack correlation matrix is taken from an article by [Pollack et al. \(2012\)](#). The globalWarm data set is the glbwarm data set in the *processR* package and added to *psychTools* with the kind permission of the original author, Erik Nisbet.

To find the confidence intervals of the effect of mediation (the reduction between the c and c' paths, where $c' = c - ab$), bootstrap the results by randomly sampling from the data with replacement (e.g n.iter = 5000) times.

For these examples, the data files Garcia ([Garcia et al., 2010](#)) and Tal_Or ([Tal-Or et al., 2010](#)) are included in the *psych* package. The *estress* data set and *globalWarm* were originally downloaded from the [Hayes \(2013\)](#) data sets. The correlation matrix for the *estress* data set is stored as *Pollack* in the *psychTools* package as is the *Globalwarm* data set. They are also available from the *processR* package [Moon \(2020\)](#).

The syntax is that $y \sim x + (m)$ where m is the mediating variable. By default the output is to two decimals, as is the graphic output. This can be increased by returning the output to an object and then printing that object with the desired number of decimals.

4.1 Simple mediation

The first example (Hayes, 2013, mod.4.5) is taken from (Tal-Or et al., 2010) and examines the mediating effect of “Presumed Media Influence” (pmi) on the intention to act (reaction) based upon the importance of a message (import). The data are in the `Tal_Or` data set in `psych` (with the kind permission of Nurit Tal-Or, Jonanathan Cohen, Yariv Tasfati, and Albert Gunther). In the Hayes (2013) book, this is the `pmi` data set.

```
R code
> data(Tal.Or)
> psych::describe(Tal_Or) #descriptive statistics
```

	vars	n	mean	sd	median	trimmed	mad	min	max	range	skew	kurtosis	se
cond	1	123	0.47	0.50	0.00	0.46	0.00	0	1	1	0.11	-2.00	0.05
pmi	2	123	5.60	1.32	6.00	5.78	1.48	1	7	6	-1.17	1.30	0.12
import	3	123	4.20	1.74	4.00	4.26	1.48	1	7	6	-0.26	-0.89	0.16
reaction	4	123	3.48	1.55	3.25	3.44	1.85	1	7	6	0.21	-0.90	0.14
gender	5	123	1.65	0.48	2.00	1.69	0.00	1	2	1	-0.62	-1.62	0.04
age	6	123	24.63	5.80	24.00	23.76	1.48	18	61	43	4.71	24.76	0.52

```
R code
> mod4.4 <- mediate(reaction ~ cond + (pmi), data =Tal_Or)
> mod4.4
```

Mediation/Moderation Analysis

Call: `mediate(y = reaction ~ cond + (pmi), data = Tal_Or)`

The DV (Y) was `reaction` . The IV (X) was `cond` . The mediating variable(s) = `pmi` .

Total effect (c) of `cond` on `reaction` = 0.5 S.E. = 0.28 t = 1.79 df= 121 with p = 0.077
Direct effect (c') of `cond` on `reaction` removing `pmi` = 0.25 S.E. = 0.26 t = 0.99 df= 120 with
Indirect effect (ab) of `cond` on `reaction` through `pmi` = 0.24
Mean bootstrapped indirect effect = 0.24 with standard error = 0.13 Lower CI = 0.01 Upper CI = 0.52
R = 0.45 R2 = 0.21 F = 15.56 on 2 and 120 DF p-value: 1.31e-08

To see the longer output, specify `short = FALSE` in the print statement or ask for the summary

```
R code
> #print(mod4.4, digits = 4) # in order to get the precision of the Hayes (2013) p 99 example
```

pdf
2

A second example from (Hayes, 2013) is an example of moderated mediated effect. The data are from (Garcia et al., 2010) and report on the effect of protest on reactions to a case of sexual discrimination.

```
R code
> data(GSBE) #alias to Garcia data set
> #compare two models (bootstrapping n.iter set to 50 for speed
> # 1) mean center the variables prior to taking product terms
> mod1 <- mediate(respappr ~ prot2 * sexism +(sexism),data=Garcia,n.iter=50
+ ,main="Moderated mediation (mean centered)")
> # 2) do not mean center
> mod2 <- mediate(respappr ~ prot2 * sexism +(sexism),data=Garcia,zero=FALSE, n.iter=50,
+ main="Moderated mediation (not centered)")
> summary(mod1)
```

Mediation model

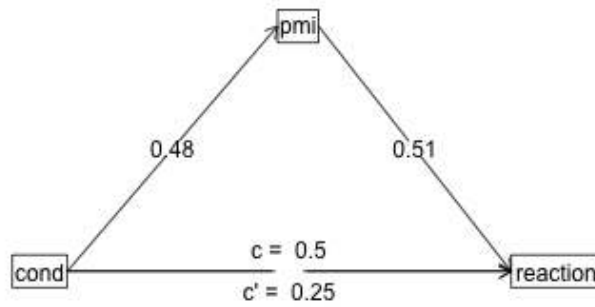

Figure 12: A simple mediation model (Hayes, 2013, p 99) with data derived from Tal-Or et al. (2010). The effect of a salience manipulation (cond) on the intention to buy a product (reaction) is mediated through the presumed media influence (pmi).

```
Call: mediate(y = respappr ~ prot2 * sexism + (sexism), data = Garcia,
  n.iter = 50, main = "Moderated mediation (mean centered)")
```

```
Direct effect estimates (traditional regression) (c') X + M on Y
      respappr se      t df      Prob
Intercept    -0.01 0.10 -0.12 125 9.07e-01
prot2         1.46 0.22  6.73 125 5.52e-10
prot2*sexism   0.81 0.28  2.87 125 4.78e-03
sexism        0.02 0.13  0.18 125 8.56e-01
```

```
R = 0.54 R2 = 0.3 F = 17.53 on 3 and 125 DF p-value: 1.46e-09
```

```
Total effect estimates (c) (X on Y)
      respappr se      t df      Prob
Intercept    -0.01 0.10 -0.12 126 9.06e-01
prot2         1.46 0.22  6.77 126 4.43e-10
prot2*sexism   0.81 0.28  2.89 126 4.49e-03
```

```
'a' effect estimates (X on M)
      sexism se      t df      Prob
Intercept    0.00 0.07 -0.02 126 0.986
prot2         0.07 0.15  0.47 126 0.642
prot2*sexism  0.09 0.19  0.44 126 0.661
```

```
'b' effect estimates (M on Y controlling for X)
      respappr se      t df      Prob
sexism       0.02 0.13  0.18 125 0.856
```

```
'ab' effect estimates (through all mediators)
      respappr boot      sd lower upper
prot2         0      0 0.03 -0.07 0.07
prot2*sexism  0      0 0.05 -0.07 0.07
```

```
> summary(mod2)
```

R code

```
Call: mediate(y = respappr ~ prot2 * sexism + (sexism), data = Garcia,
  n.iter = 50, zero = FALSE, main = "Moderated mediation (not centered)")
```

```
Direct effect estimates (traditional regression) (c') X + M on Y
      respappr se      t df      Prob
Intercept     6.57 1.21  5.43 125 2.83e-07
prot2        -2.69 1.45 -1.85 125 6.65e-02
prot2*sexism   0.81 0.28  2.87 125 4.78e-03
sexism       -0.53 0.24 -2.24 125 2.67e-02
```

```
R = 0.54 R2 = 0.3 F = 17.53 on 3 and 125 DF p-value: 1.46e-09
```

```
Total effect estimates (c) (X on Y)
      respappr se      t df      Prob
Intercept     3.88 0.18 21.39 126 9.14e-44
prot2          0.00 0.84  0.00 126 9.96e-01
prot2*sexism   0.28 0.16  1.79 126 7.56e-02
```

```
'a' effect estimates (X on M)
      sexism se      t df      Prob
Intercept     5.07 0.07 75.12 126 1.69e-106
prot2        -5.07 0.31 -16.33 126 6.81e-33
prot2*sexism  1.00 0.06 17.15 126 9.41e-35
```

```

'b' effect estimates (M on Y controlling for X)
      respappr  se      t  df  Prob
sexism   -0.53 0.24 -2.24 125 0.0267

'ab' effect estimates (through all mediators)
      respappr boot  sd lower upper
prot2      2.68 2.58 1.83 -0.59 5.37
prot2*sexism -0.53 -0.51 0.36 -0.59 5.37

```

4.2 Multiple mediators

It is trivial to show the effect of multiple mediators. Do this by adding the second (or third) mediator into the equation. Use the `Tal_Or` data set (Tal-Or et al., 2010) again. Show the graphical representation in Figure 13.

```

R code
> mod5.4 <- mediate(reaction ~ cond + (import) + (pmi), data = Tal_Or)
> print(mod5.4, digits=4) #to compare with Hayes

```

Mediation/Moderation Analysis

```
Call: mediate(y = reaction ~ cond + (import) + (pmi), data = Tal_Or)
```

```
The DV (Y) was reaction . The IV (X) was cond . The mediating variable(s) = import pmi .
```

```
Total effect (c) of cond on reaction = 0.4957 S.E. = 0.2775 t = 1.786 df= 121 with p = 0.0766
Direct effect (c') of cond on reaction removing import pmi = 0.1034 S.E. = 0.2391 t = 0.4324 d
Indirect effect (ab) of cond on reaction through import pmi = 0.3923
Mean bootstrapped indirect effect = 0.394 with standard error = 0.1641 Lower CI = 0.0824 Upper CI =
R = 0.5702 R2 = 0.3251 F = 19.1118 on 3 and 119 DF p-value: 3.6636e-12
```

To see the longer output, specify `short = FALSE` in the print statement or ask for the summary

```

R code
>

```

pdf
2

4.3 Serial mediators

The example from Hayes (2013) for two mediators, where one effects the second, is a bit more complicated and currently can be done by combining two separate analyses. The first is just model 5.4, the second is the effect of `cond` on `pmi` mediated by `import`.

Combining the two results leads to the output found on (Hayes, 2013, page 153).

pdf
2

```

R code
> #model 5.4 + mod5.7 is the two chained mediator model
> mod5.7 <- mediate(pmi ~ cond + (import) , data = Tal_Or)
> summary(mod5.7, digits=4)

```

Hayes example 5.3

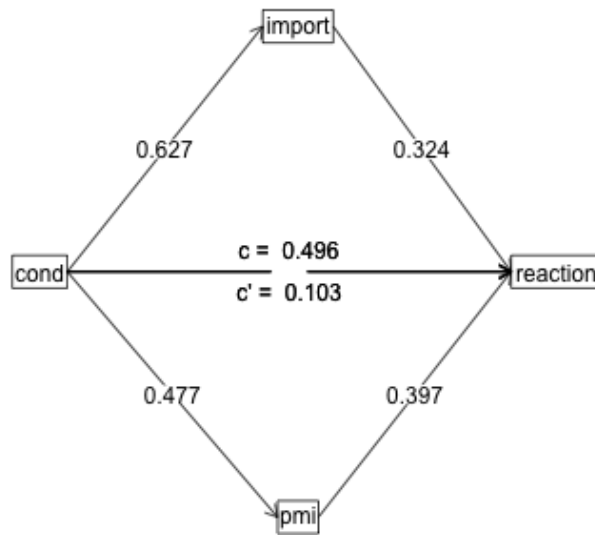

Figure 13: A mediation model with two mediators (Hayes, 2013, p 131). The data are data derived from Tal-Or et al. (2010). The effect of a salience manipulation (cond) on the intention to buy a product (reaction) is mediated through the presumed media influence (pmi) and importance of the message (import).

```
Call: mediate(y = pmi ~ cond + (import), data = Tal_Or)
```

```
Direct effect estimates (traditional regression) (c') X + M on Y
      pmi      se      t      df      Prob
Intercept 4.6104 0.3057 15.0836 120 1.7543e-29
cond      0.3536 0.2325  1.5207 120 1.3096e-01
import    0.1961 0.0671  2.9228 120 4.1467e-03
```

```
R = 0.3114 R2 = 0.097 F = 6.4428 on 2 and 120 DF p-value: 0.0021989
```

```
Total effect estimates (c) (X on Y)
      pmi      se      t      df      Prob
Intercept 5.3769 0.1618 33.2222 121 1.1593e-62
cond      0.4765 0.2357  2.0218 121 4.5401e-02
```

```
'a' effect estimates (X on M)
      import      se      t      df      Prob
Intercept 3.9077 0.2127 18.3704 121 8.3936e-37
cond      0.6268 0.3098  2.0234 121 4.5235e-02
```

```
'b' effect estimates (M on Y controlling for X)
      pmi      se      t      df      Prob
import 0.1961 0.0671 2.9228 120 0.0041467
```

```
'ab' effect estimates (through all mediators)
      pmi boot      sd lower upper
cond 0.1229 0.1268 0.0877 -0.0013 0.3352
```

4.4 Single mediators, multiple covariates

The Pollack data set (Pollack et al., 2012) is used as an example of multiple covariates (included in *psychTools* as a correlation matrix). The raw data are available from the *processR* package as *estress*. Confidence in executive decision making (“Entrepreneurial self-efficacy), gender (sex), and length of time in business (tenure) are used as covariates. There are two ways of doing this: enter them as predictors of the criterion or to partial them out. The first approach estimates their effects, the second just removes them.

R code

```
> lowerMat(Pollack)
```

```
sex      sex  age  tenur slf.f cmptn scl.t ecnm. dprss wthdr
sex      1.00
age      0.07 1.00
tenure   0.03 0.32 1.00
self.efficacy -0.02 -0.09 -0.06 1.00
competence 0.08 0.01 0.02 0.22 1.00
social.ties 0.07 -0.06 0.01 0.19 0.13 1.00
economic.stress -0.15 0.09 0.07 -0.16 -0.09 -0.07 1.00
depression -0.05 -0.02 -0.07 -0.25 0.06 -0.05 0.34 1.00
withdrawal -0.03 -0.05 -0.04 -0.24 -0.09 0.01 0.06 0.42 1.00
```

R code

```
> mod6.2 <- mediate(withdrawal ~ economic.stress + self.efficacy + sex + tenure + (depression),
+ data=Pollack, n.obs=262)
> summary(mod6.2)
```

```
Call: mediate(y = withdrawal ~ economic.stress + self.efficacy + sex +
  tenure + (depression), data = Pollack, n.obs = 262)
```

```
Direct effect estimates (traditional regression) (c') X + M on Y
      withdrawal se t df Prob
Intercept      0.00 0.06 0.00 256 1.00e+00
economic.stress -0.11 0.06 -1.82 256 6.99e-02
self.efficacy   -0.15 0.06 -2.67 256 8.01e-03
sex             -0.03 0.06 -0.50 256 6.15e-01
tenure          -0.01 0.06 -0.21 256 8.37e-01
depression      0.42 0.06 6.83 256 6.05e-11
```

```
R = 0.45 R2 = 0.21 F = 13.35 on 5 and 256 DF p-value: 1.45e-11
```

```
Total effect estimates (c) (X on Y)
      withdrawal se t df Prob
Intercept      0.00 0.06 0.00 257 1.000000
economic.stress 0.02 0.06 0.34 257 0.737000
self.efficacy   -0.24 0.06 -3.92 257 0.000113
sex             -0.03 0.06 -0.49 257 0.624000
tenure          -0.05 0.06 -0.91 257 0.366000
```

```
'a' effect estimates (X on M)
      depression se t df Prob
Intercept      0.00 0.06 0.00 257 1.00e+00
economic.stress 0.31 0.06 5.36 257 1.88e-07
self.efficacy   -0.21 0.06 -3.56 257 4.36e-04
sex             0.00 0.06 -0.07 257 9.46e-01
tenure          -0.10 0.06 -1.82 257 6.98e-02
```

```
'b' effect estimates (M on Y controlling for X)
      withdrawal se t df Prob
depression      0.42 0.06 6.83 256 6.05e-11
```

```
'ab' effect estimates (through all mediators)
      withdrawal boot sd lower upper
economic.stress 0.13 0.13 0.03 0.08 0.19
self.efficacy   -0.09 -0.05 0.03 0.08 0.19
sex             0.00 -0.02 0.02 0.08 0.19
tenure          -0.04 -0.06 0.03 0.08 0.19
```

```
pdf
  2
```

The graphical output (Figure 14) looks a bit more complicated than the figure in (Hayes, 2013, p 177) because I am showing the covariates as causal paths.

4.5 Single predictor, single criterion, multiple covariates

An alternative way to display the previous results is to remove the three covariates from the mediation model. Do this by partialling out the covariates. This is represented in the `mediate` code by a negative sign (Figure 15)

```
R code
> mod6.2a <- mediate(withdrawal ~ economic.stress -self.efficacy - sex - tenure + (depression),
+ data=Pollack, n.obs=262)
```

Simple mediation, 3 covariates

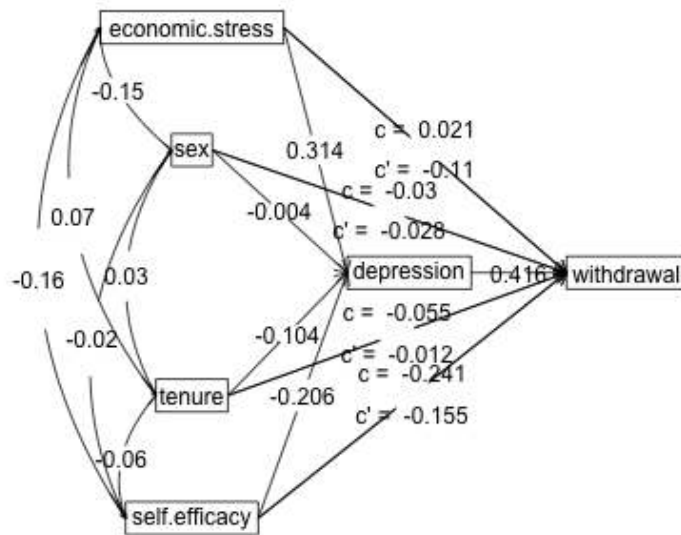

Figure 14: A mediation model with three covariates (Hayes, 2013, p 177). Compare this to the solution in which they are partialled out. (Figure 15).

```
> summary(mod6.2a)
```

```
Call: mediate(y = withdrawal ~ economic.stress - self.efficacy - sex -  
  tenure + (depression), data = Pollack, n.obs = 262)
```

```
Direct effect estimates (traditional regression) (c') X + M on Y  
      withdrawal*  se    t  df  Prob  
Intercept          0.00 0.06  0.00 256 1.00e+00  
economic.stress   -0.11 0.06 -1.80 256 7.23e-02  
depression         0.42 0.06  6.78 256 8.50e-11
```

```
R = 0.39 R2 = 0.15  F = 23.41 on 2 and 256 DF  p-value: 4.6e-10
```

```
Total effect estimates (c) (X on Y)  
      withdrawal*  se    t  df  Prob  
Intercept          0.00 0.06  0.00 257 1.000  
economic.stress    0.02 0.06  0.34 257 0.737
```

```
'a' effect estimates (X on M)  
      depression  se    t  df  Prob  
Intercept        0.00 0.06  0.00 257 1.00e+00  
economic.stress  0.31 0.06  5.36 257 1.88e-07
```

```
'b' effect estimates (M on Y controlling for X)  
      withdrawal*  se    t  df  Prob  
depression        0.42 0.06  6.83 256 6.05e-11
```

```
'ab' effect estimates (through all mediators)  
      withdrawal* boot  sd lower upper  
economic.stress    0.13 0.11 0.03 0.05 0.17
```

```
pdf  
  2
```

4.6 Multiple predictors, single criterion

It is straightforward to use multiple predictors see (Hayes, 2013, p196) and in fact did so in the previous example where the predictors were treated as *covariates*. `mediate` also allows for multiple criteria.

5 Mediation and moderation

We already saw how to do moderation in the discussion of `lmCor`. Combining the concepts of mediation with moderation is done in `mediate`. That is, find the linear model of product terms as they are associated with dependent variables and regressed on the mediating variables.

The Garcia data set (Garcia et al., 2010) can be used for an example of moderation. (This was taken from (Hayes, 2013) but is used with kind permission of Donna M. Garcia, Michael T. Schmitt, Nyla R. Branscombe, and Naomi Ellemers.) Just as `setCor` and `lm` will find the interaction term by forming a product, so will `mediate`. Notice that by default, `lmCor` reports zero centered and standardized regressions, `mediate` reports zero centered but not standardized regressions, and

Simple mediation, 3 covariates (partialled out)

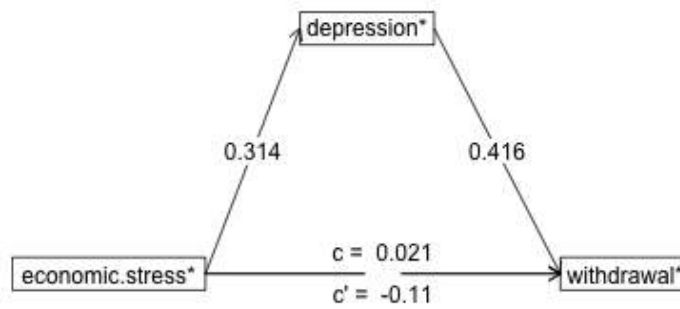

Figure 15: Show the mediation model from Figure 14 with the covariates (ese, sex, tenure) removed.

some of the examples from [Hayes \(2013\)](#) do not zero center the data. Thus, I specify `zero=FALSE` to get the [Hayes \(2013\)](#) results.

It is important to note that the `protest` data set discussed here is from the 2013 examples and not the more recent 2018 examples available from [afhayes.com](#). The 2013 data have a dichotomous protest variable, while the 2018 data set has three levels for the protest variable. The `Garcia` data set is composed of the 2018 data set with the addition of a dichotomous variable (`prot2`) to match the 2013 examples.

We consider how the interaction of sexism with protest affects the mediation effect of sexism ([Hayes, 2013](#), p 362), I contrast the `lm`, `lmCor` and `mediate` approaches. For reasons to be discussed in the next section, I do not zero center the variables. The graphic output is in [Figure 16](#) and the output is below. For comparison purposes, I show the results from the `lm` as well as `lmCor` and `mediate`.

```

R code
> summary(lm(respappr ~ prot2 * sexism,data = Garcia)) #show the lm results for comparison

Call:
lm(formula = respappr ~ prot2 * sexism, data = Garcia)

Residuals:
    Min       1Q   Median       3Q      Max
-3.4984 -0.7540  0.0801  0.8301  3.1853

Coefficients:
            Estimate Std. Error t value Pr(>|t|)
(Intercept)   6.5667     1.2095   5.429 2.83e-07 ***
prot2         -2.6866     1.4515  -1.851 0.06654 .
sexism        -0.5290     0.2359  -2.243 0.02668 *
prot2:sexism   0.8100     0.2819   2.873 0.00478 **
---
Signif. codes:  0 '***' 0.001 '**' 0.01 '*' 0.05 '.' 0.1 ' ' 1

Residual standard error: 1.144 on 125 degrees of freedom
Multiple R-squared:  0.2962,    Adjusted R-squared:  0.2793
F-statistic: 17.53 on 3 and 125 DF,  p-value: 1.456e-09

```

```

R code
> #show the lmCor analysis
> lmCor(respappr ~ prot2* sexism ,data=Garcia,zero=FALSE,main="Moderation",std=FALSE)

Call: lmCor(y = respappr ~ prot2 * sexism, data = Garcia, std = FALSE,
            main = "Moderation", zero = FALSE)

Multiple Regression from raw data

DV = respappr
      slope  se    t      p lower.ci upper.ci  VIF  Vy.x
(Intercept)  6.57 1.21  5.43 2.8e-07    4.17    8.96  1.00  0.00
prot2        -2.69 1.45 -1.85 6.7e-02   -5.56    0.19 44.99 -0.47
sexism       -0.53 0.24 -2.24 2.7e-02   -1.00   -0.06  3.34 -0.01
prot2*sexism  0.81 0.28  2.87 4.8e-03    0.25    1.37 48.14  0.77

Residual Standard Error = 1.14 with 125 degrees of freedom

```

```

Multiple Regression
      R  R2  Ruw R2uw Shrunkn R2 SE of R2 overall F df1 df2      p
respappr 0.54 0.3 0.41 0.17      0.28    0.06    17.53   3 125 1.46e-09
R code
> #then show the mediate results
>
> modgarcia <-mediate(respappr ~ prot2 * sexism +(sexism),data=Garcia,zero=FALSE,main="Moderated mediation")
> summary(modgarcia)

```

Call: mediate(y = respappr ~ prot2 * sexism + (sexism), data = Garcia, zero = FALSE, main = "Moderated mediation")

Direct effect estimates (traditional regression) (c') X + M on Y

	respappr	se	t	df	Prob
Intercept	6.57	1.21	5.43	125	2.83e-07
prot2	-2.69	1.45	-1.85	125	6.65e-02
prot2*sexism	0.81	0.28	2.87	125	4.78e-03
sexism	-0.53	0.24	-2.24	125	2.67e-02

R = 0.54 R2 = 0.3 F = 17.53 on 3 and 125 DF p-value: 1.46e-09

Total effect estimates (c) (X on Y)

	respappr	se	t	df	Prob
Intercept	3.88	0.18	21.39	126	9.14e-44
prot2	0.00	0.84	0.00	126	9.96e-01
prot2*sexism	0.28	0.16	1.79	126	7.56e-02

'a' effect estimates (X on M)

	sexism	se	t	df	Prob
Intercept	5.07	0.07	75.12	126	1.69e-106
prot2	-5.07	0.31	-16.33	126	6.81e-33
prot2*sexism	1.00	0.06	17.15	126	9.41e-35

'b' effect estimates (M on Y controlling for X)

	respappr	se	t	df	Prob
sexism	-0.53	0.24	-2.24	125	0.0267

'ab' effect estimates (through all mediators)

	respappr	boot	sd	lower	upper
prot2	2.68	2.66	1.61	-0.71	5.57
prot2*sexism	-0.53	-0.52	0.32	-0.71	5.57

```

R code
>

```

pdf
2

5.1 To center or not to center, that is the question

We have discussed the difference between zero centering and not zero centering. Although [Hayes \(2013\)](#) seems to prefer not centering, some of his examples are in fact centered. So, when we examine Table 8.2 and try to replicate the regression, we need to zero center the data.

With the global warming data from [Hayes \(2013\)](#), the default (uncentered) regression does not

An example of moderated mediation

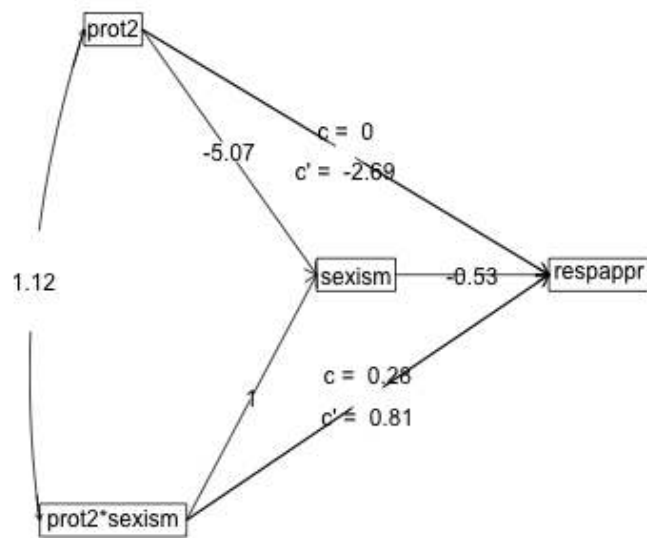

Figure 16: Moderated mediation from (Hayes, 2013, p 362). The data are from Garcia et al. (2010).

reproduce his Table, but zero centering does. To this in `lm` requires two steps, but we can do this in `lmCor` with the `zero=TRUE` or `zero=FALSE` option.

```
> lm(govact ~ age * negemot + posemot + ideology + sex, data=globalWarm)
```

Call:
`lm(formula = govact ~ age * negemot + posemot + ideology + sex, data = globalWarm)`

Coefficients:
 (Intercept) age negemot posemot ideology sex age:negemot
 5.173849 -0.023879 0.119583 -0.021419 -0.211515 -0.011191 0.006331

```
> # but zero center and try again  

> glbwarmc <- data.frame(scale(globalWarm, scale=FALSE))  

> lm(govact ~ age * negemot + posemot + ideology + sex, data=globalWarm)
```

Call:
`lm(formula = govact ~ age * negemot + posemot + ideology + sex, data = globalWarm)`

Coefficients:
 (Intercept) age negemot posemot ideology sex age:negemot
 5.173849 -0.023879 0.119583 -0.021419 -0.211515 -0.011191 0.006331

```
> mod.glb <- lmCor(govact ~ age * negemot + posemot + ideology + sex, data=globalWarm, zero=FALSE, std=FALSE)  

> print(mod.glb, digits=6)
```

Call: `lmCor(y = govact ~ age * negemot + posemot + ideology + sex, data = globalWarm, std = FALSE, zero = FALSE)`

Multiple Regression from raw data

DV = govact		slope	se	t	p	lower.ci	upper.ci	VIF	Vy.x
(Intercept)	5.173849	0.338451	15.286838	1.58157e-46	4.509502	5.838197	1.000000	0.000000	
age	-0.023879	0.005980	-3.992944	7.12038e-05	-0.035618	-0.012140	6.949401	0.027844	
negemot	0.119583	0.082535	1.448881	1.47759e-01	-0.042425	0.281591	11.594520	0.077620	
posemot	-0.021419	0.027904	-0.767597	4.42951e-01	-0.076193	0.033354	1.028663	-0.000912	
ideology	-0.211515	0.026833	-7.882678	1.03603e-14	-0.264185	-0.158845	1.198910	0.098323	
sex	-0.011191	0.076003	-0.147240	8.82979e-01	-0.160378	0.137997	1.052907	0.000406	
age*negemot	0.006331	0.001543	4.103542	4.48155e-05	0.003302	0.009359	16.455422	0.197526	

Residual Standard Error = 1.056984 with 808 degrees of freedom

Multiple Regression	R	R2	Ruw	R2uw	Shrunken R2	SE of R2	overall F	df1	df2	p
govact	0.633093	0.400806	0.14033	0.019693	0.396357	0.026299	90.07983	6	808	1.824604e-86

```
> mod.glb0 <- lmCor(govact ~ age * negemot + posemot + ideology + sex, data=globalWarm, std=FALSE)  

> print(mod.glb0, digits=6)
```

Call: `lmCor(y = govact ~ age * negemot + posemot + ideology + sex, data = globalWarm, std = FALSE)`

Multiple Regression from raw data

```
DV = govact
      slope      se      t      p  lower.ci  upper.ci  VIF  Vy.x
(Intercept)  4.595973 0.037089 123.916910 0.00000e+00  4.523171  4.668776 1.000000  0.000000
age          -0.001354 0.002348  -0.576864 5.64192e-01 -0.005963  0.003254 1.071058  0.001579
negemot      0.433184 0.026243  16.506679 5.75775e-53  0.381671  0.484696 1.172207  0.281175
posemot      -0.021419 0.027904  -0.767597 4.42951e-01 -0.076193  0.033354 1.028663 -0.000912
ideology     -0.211515 0.026833  -7.882678 1.03603e-14 -0.264185 -0.158845 1.198910  0.098323
sex          -0.011191 0.076003  -0.147240 8.82979e-01 -0.160378  0.137997 1.052907  0.000406
age*negemot  0.006331 0.001543  4.103542 4.48155e-05  0.003302  0.009359 1.014744  0.020236
```

Residual Standard Error = 1.056984 with 808 degrees of freedom

```
Multiple Regression
      R      R2      Ruw      R2uw Shrunken R2 SE of R2 overall F df1 df2      p
govact 0.633093 0.400806 0.355865 0.12664  0.396357 0.026299 90.07983  6 808 1.824604e-86
```

So, when we do the mediated moderation model, we need to use the zero centered option to match the [Hayes \(2013\)](#) results from Figure 8.5.

```
R code
> #by default, mediate zero centers before finding the products
> mod.glb <- mediate(govact ~ age * negemot + posemot + ideology + sex + (age), data=globalWarm, zero=TRUE)
> summary(mod.glb, digits=4)
```

```
Call: mediate(y = govact ~ age * negemot + posemot + ideology + sex +
              (age), data = globalWarm, zero = TRUE)
```

```
Direct effect estimates (traditional regression)      (c') X + M on Y
      govact      se      t      df      Prob
Intercept  0.0090 0.0371  0.2421 808 8.0876e-01
negemot    0.4332 0.0262 16.5067 808 5.7578e-53
posemot    -0.0214 0.0279 -0.7676 808 4.4295e-01
ideology   -0.2115 0.0268 -7.8827 808 1.0360e-14
sex        -0.0112 0.0760 -0.1472 808 8.8298e-01
age*negemot 0.0063 0.0015  4.1035 808 4.4816e-05
age        -0.0014 0.0023 -0.5769 808 5.6419e-01
```

R = 0.6331 R2 = 0.4008 F = 90.0798 on 6 and 808 DF p-value: 1.8246e-86

```
Total effect estimates (c) (X on Y)
      govact      se      t      df      Prob
Intercept  0.0090 0.0371  0.2420 809 8.0881e-01
negemot    0.4328 0.0262 16.5043 809 5.8181e-53
posemot    -0.0220 0.0279 -0.7890 809 4.3036e-01
ideology   -0.2145 0.0263 -8.1510 809 1.3690e-15
sex        -0.0173 0.0752 -0.2304 809 8.1783e-01
age*negemot 0.0063 0.0015  4.1025 809 4.4999e-05
```

```
'a' effect estimates (X on M)
      age      se      t      df      Prob
Intercept  0.0044 0.5554  0.0079 809 9.9366e-01
negemot    0.2757 0.3929  0.7017 809 4.8305e-01
posemot    0.4232 0.4176  1.0135 809 3.1112e-01
ideology   2.2079 0.3943  5.6002 809 2.9334e-08
sex        4.5345 1.1269  4.0238 809 6.2643e-05
age*negemot 0.0031 0.0231  0.1346 809 8.9294e-01
```

```
'b' effect estimates (M on Y controlling for X)
```

```

      govact      se      t  df  Prob
age -0.0014 0.0023 -0.5769 808 0.56419

'ab' effect estimates (through all mediators)
      govact      boot      sd  lower upper
negemot -0.0004 -0.0004 0.0012 -0.0032 0.0017
posemot -0.0006 -0.0005 0.0015 -0.0032 0.0017
ideology -0.0030 -0.0029 0.0051 -0.0032 0.0017
sex -0.0061 -0.0057 0.0106 -0.0032 0.0017
age*negemot 0.0000 0.0000 0.0001 -0.0032 0.0017

```

Compare this output to that of Table 8.2 and Figure 8.5 (p 258 - 259).

5.2 Another example of moderated mediation

The Garcia data set (`protest` in Hayes (2013)) is another example of a moderated analysis. Use either `lmCor` or `mediate` to examine this data set. The defaults for these two differ, in that `lmCor` assumes we want to zero center *and* standardize, while `mediate` defaults to not standardizing but also defaults to zero (mean) centering. Note that in the next examples we specify we do not want to standardize nor to mean center.

```

> psych::describe(Garcia)

```

```

      vars  n mean  sd median trimmed mad min max range skew kurtosis  se
protest   1 129 1.03 0.82  1.00  1.04 1.48 0.00  2  2.00 -0.06  -1.52 0.07
sexism    2 129 5.12 0.78  5.12  5.10 0.74 2.87  7  4.13  0.12  -0.32 0.07
anger     3 129 2.12 1.66  1.00  1.84 0.00 1.00  7  6.00  1.29   0.26 0.15
liking    4 129 5.64 1.05  5.83  5.73 0.99 1.00  7  6.00 -1.15   2.48 0.09
respappr  5 129 4.87 1.35  5.25  4.98 1.11 1.50  7  5.50 -0.75  -0.18 0.12
prot2     6 129 0.68 0.47  1.00  0.72 0.00 0.00  1  1.00 -0.77  -1.41 0.04

```

```

> lm(liking ~ prot2* sexism + respappr, data=Garcia)

```

```

Call:
lm(formula = liking ~ prot2 * sexism + respappr, data = Garcia)

```

```

Coefficients:
(Intercept)      prot2      sexism      respappr  prot2:sexism
  5.3471      -2.8075     -0.2824      0.3593      0.5426

```

```

> lmCor(liking ~ prot2* sexism + respappr, data = Garcia, zero=FALSE, std=FALSE)

```

```

Call: lmCor(y = liking ~ prot2 * sexism + respappr, data = Garcia,
  std = FALSE, zero = FALSE)

```

Multiple Regression from raw data

```

DV = liking
      slope  se      t      p lower.ci upper.ci  VIF  Vy.x
(Intercept)  5.35 1.06  5.04 1.6e-06  3.25  7.45 1.00  0.00
prot2        -2.81 1.16 -2.42 1.7e-02 -5.10 -0.51 46.22 -0.27
sexism       -0.28 0.19 -1.49 1.4e-01 -0.66  0.09  3.47 -0.02
respappr     0.36 0.07  5.09 1.3e-06  0.22  0.50  1.42  0.23
prot2*sexism  0.54 0.23  2.36 2.0e-02  0.09  1.00 51.32  0.34

```

Residual Standard Error = 0.9 with 124 degrees of freedom

Multiple Regression

	R	R2	Ruw	R2uw	Shrunken R2	SE of R2	overall F	df1	df2	p
liking	0.53	0.28	0.34	0.12	0.26	0.06	12.26	4	124	1.99e-08

R code

```
> mod7.4 <- mediate(liking ~ prot2 * sexism + respappr, data = Garcia, zero=FALSE)
> summary(mod7.4)
```

Call: mediate(y = liking ~ prot2 * sexism + respappr, data = Garcia, zero = FALSE)

No mediator specified leads to traditional regression

	liking	se	t	df	Prob
Intercept	5.35	1.06	5.04	124	1.60e-06
prot2	-2.81	1.16	-2.42	124	1.70e-02
sexism	-0.28	0.19	-1.49	124	1.39e-01
respappr	0.36	0.07	5.09	124	1.28e-06
prot2*sexism	0.54	0.23	2.36	124	1.97e-02

R = 0.53 R2 = 0.28 F = 12.26 on 4 and 124 DF p-value: 1.99e-08

pdf
2

5.3 Graphic Displays of Interactions

In order to graphically display interactions, particularly if one of the variable is categorical, plot separate regression lines for each value of the categorical variable. Do this for the Garcia data set to show the interaction of protest with sexism. (see Figure 18). This is just an example of how to use Core-R to do graphics and is not a feature of *psych*.

R code

```
> png('garciainteraction.png')
> plot(respappr ~ sexism, pch = 23- protest, bg = c("black", "red", "blue")[protest],
+ data=Garcia, main = "Response to sexism varies as type of protest")
> by(Garcia, Garcia$protest, function(x) abline(lm(respappr ~ sexism,
+ data =x), lty=c("solid", "dashed", "dotted")[x$protest+1]))
```

Garcia\$protest: 0
NULL

Garcia\$protest: 1
NULL

Garcia\$protest: 2
NULL

R code

```
> text(6.5, 3.5, "No protest")
> text(3, 3.9, "Individual")
> text(3, 5.2, "Collective")
> dev.off()
```

pdf
2

Another example of moderated mediation

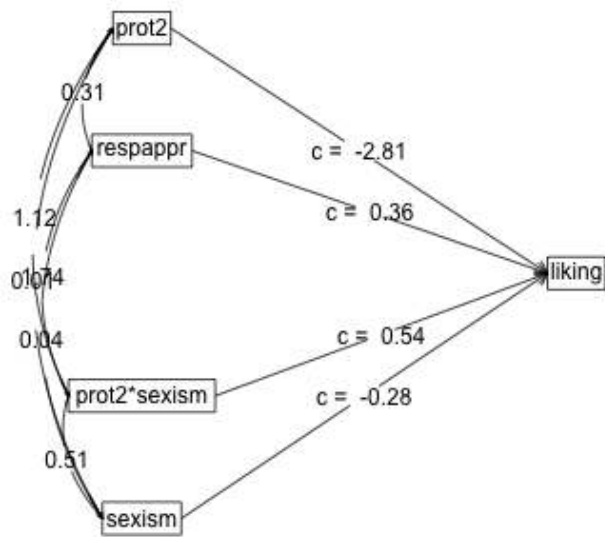

Figure 17: A simple moderated regression analysis of the `protest` data set. The data were not zero centered. This shows the strength of the three regressions. Figure 18 shows the actual data and the three regression lines.

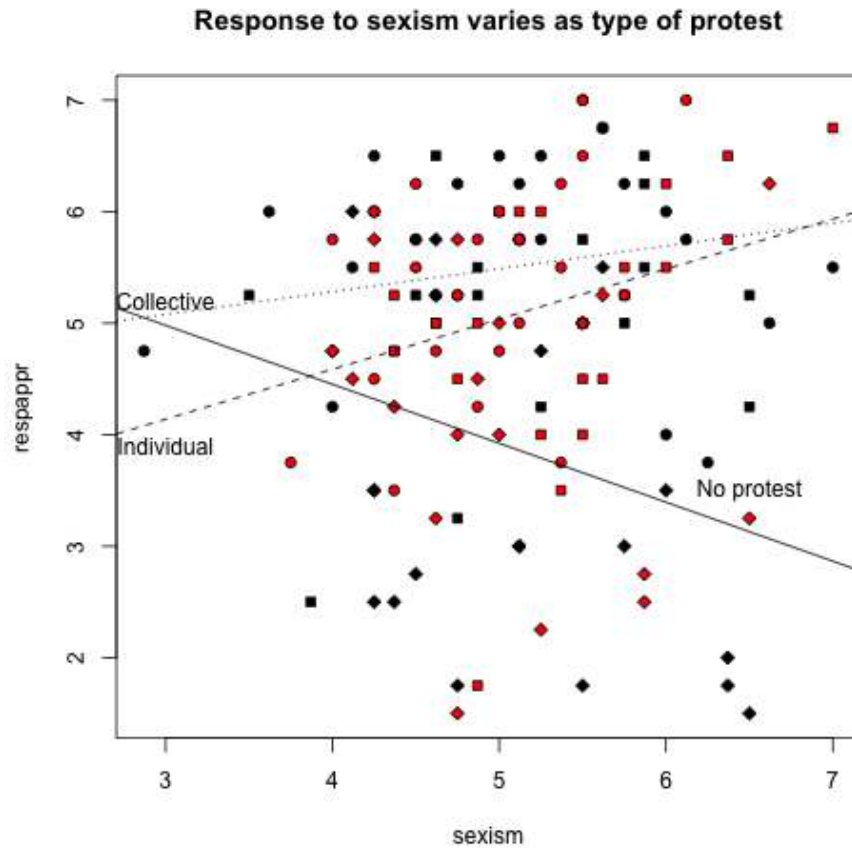

Figure 18: Showing the interaction between type of protest and sexism from the Garcia data set. The strength of the regression effects is shown in Fig 17.

6 Partial Correlations

Although not strictly speaking part of mediation or moderation, the use of *partial correlations* can be addressed here. s

6.1 Partial some variables from the rest of the variables

Given a set of X variables and a set of Y variables, we can control for an additional set of Z variables when we find the correlations between X and Y. This is effectively what happens when we want to add covariates into a model. We see this when we compare the regression model for government action as a function of the interaction of ideology and age with some covariates, or when we partial them out first.

```
> #first, the more complicated model
> mod.glb <- lmCor(govact ~ age * negemot + posemot + ideology + sex,
+                 data=globalWarm, std=FALSE)
> print(mod.glb, digits=3)
```

```
Call: lmCor(y = govact ~ age * negemot + posemot + ideology + sex,
            data = globalWarm, std = FALSE)
```

Multiple Regression from raw data

```
DV = govact
      slope   se      t      p lower.ci upper.ci  VIF  Vy.x
(Intercept) 4.596 0.037 123.917 0.00e+00  4.523  4.669 1.000  0.000
age         -0.001 0.002  -0.577 5.64e-01  -0.006  0.003 1.071  0.002
negemot      0.433 0.026  16.507 5.76e-53   0.382  0.485 1.172  0.281
posemot     -0.021 0.028  -0.768 4.43e-01  -0.076  0.033 1.029 -0.001
ideology    -0.212 0.027  -7.883 1.04e-14  -0.264  -0.159 1.199  0.098
sex         -0.011 0.076  -0.147 8.83e-01  -0.160  0.138 1.053  0.000
age*negemot 0.006 0.002   4.104 4.48e-05   0.003  0.009 1.015  0.020
```

Residual Standard Error = 1.057 with 808 degrees of freedom

```
Multiple Regression
      R    R2  Ruw R2uw Shrunken R2 SE of R2 overall F df1 df2      p
govact 0.633 0.401 0.356 0.127      0.396  0.026  90.08  6 808 1.825e-86
```

```
> # compare this to the partialled model
>
> mod.glb.partialled <- lmCor(govact ~ age * negemot - posemot - ideology - sex, data = globalWarm)
>
```

Note how the beta weights for the age, negemot and interaction terms are identical.

6.2 Partial everything from everything

Sometimes we want to examine just the independent effects of all our variables. That is to say, we want to partial all the variables from all the other variables. I do this with the `partial.r` function. To show the results, I compare the partialled rs to the original rs. I show the lower off diagonal matrix using `lowerMat`. Then to compare the partial matrix to the original matrix, I form the square matrix where the lower off diagonal is the original matrix and the upper off diagonal is the partial matrix.

R code

```
> upper <- partial.r(globalWarm)
> lowerMat(upper) #show it
```

```
      govct posmt negmt idlgy age  sex  prtyd
govact  1.00
posemot -0.03  1.00
negemot  0.50  0.13  1.00
ideology -0.19  0.00 -0.07  1.00
age     -0.02  0.04  0.03  0.14  1.00
sex      0.00  0.08 -0.07  0.04  0.14  1.00
partyid -0.08 -0.01 -0.09  0.53  0.03  0.02  1.00
```

R code

```
> lower <- lowerCor(globalWarm)
```

```
      govct posmt negmt idlgy age  sex  prtyd
govact  1.00
posemot  0.04  1.00
negemot  0.58  0.13  1.00
ideology -0.42 -0.03 -0.35  1.00
age     -0.10  0.04 -0.06  0.21  1.00
sex     -0.10  0.07 -0.12  0.13  0.17  1.00
partyid -0.36 -0.04 -0.32  0.62  0.15  0.11  1.00
```

R code

```
> lowup <- lowerUpper(lower, upper)
>
```

pdf
2

7 Related packages

`mediate` and `lmCor` are just two functions in the *psych* package. There are several additional packages available in R to do mediation. The *mediation* package (Tingley et al., 2014) seems the most powerful, in that is tailor made for mediation. *MBESS* (Kelley, 2017) has a mediation function. Steven Short has a nice tutorial on mediation analysis available for download [that discusses how to use R for mediation](#). And, of course, the *lavaan* package (Rosseel, 2012) is the recommended package to do SEM and path models.

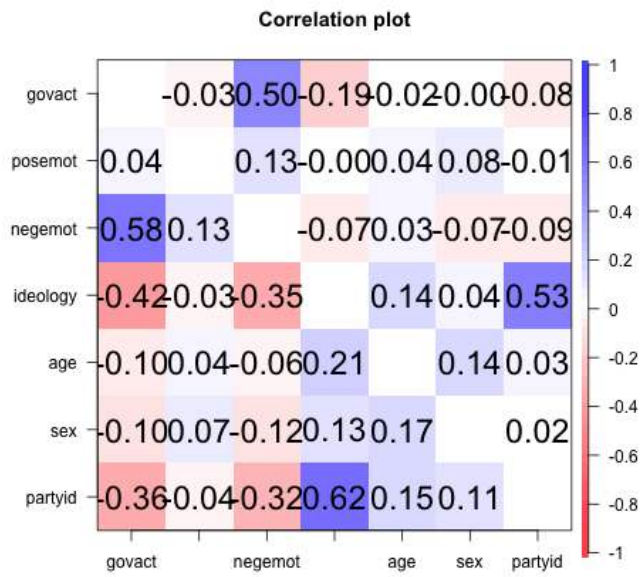

Figure 19: Correlations (below diagonal) and partial correlations (above the diagonal)

8 Development version and a users guide

The *psych* package is available from the CRAN repository. However, the most recent development version of the *psych* package is available as a source file at the repository maintained at <http://personality-project.org/r>. That version will have removed the most recently discovered bugs (but perhaps introduced other, yet to be discovered ones). To install this development version, either for PCs or Macs,

```
install.packages("psych", repos = "http://personality-project.org/r", type = "source")
```

After doing this, it is important to restart R to get the new package.

Although the individual help pages for the *psych* package are available as part of R and may be accessed directly (e.g. `?psych`), the full manual for the *psych* package is also available as a pdf at http://personality-project.org/r/psych_manual.pdf

News and a history of changes are available in the NEWS and CHANGES files in the source files. To view the most recent news,

```
> news (Version >= "2.3.12", package="psych")
```

9 Psychometric Theory

The *psych* package has been developed to help psychologists (and other quantitative scientists) do basic research. Many of the functions were developed to supplement a book (<http://personality-project.org/r/book> An introduction to Psychometric Theory with Applications in R (Revelle, prep) More information about the use of some of the functions may be found in the book .

For more extensive discussion of the use of *psych* in particular and R in general, consult http://personality-project.org/r/r_guide.html A short guide to R.

10 SessionInfo

This document was prepared using the following settings.

```
> sessionInfo()
```

```
R version 4.3.2 (2023-10-31)
Platform: aarch64-apple-darwin20 (64-bit)
Running under: macOS Sonoma 14.2.1
```

```
Matrix products: default
```

```
BLAS: /Library/Frameworks/R.framework/Versions/4.3-arm64/Resources/lib/libRblas.0.dylib
```

```
LAPACK: /Library/Frameworks/R.framework/Versions/4.3-arm64/Resources/lib/libRlapack.dylib; LAPACK version 3
```

locale:

[1] C

time zone: America/Chicago

tzcode source: internal

attached base packages:

[1] stats graphics grDevices utils datasets methods base

other attached packages:

[1] psychTools_2.4.3 psych_2.4.3

loaded via a namespace (and not attached):

[1] compiler_4.3.2	parallel_4.3.2	tools_4.3.2	foreign_0.8-85	R.methodsS3_1.8.2
[6] nlme_3.1-163	mnormt_2.1.1	grid_4.3.2	knitr_1.45	xfun_0.41
[11] rtf_0.4-14.1	R.oo_1.25.0	lattice_0.21-9		

References

- Cohen, J. (1982). Set correlation as a general multivariate data-analytic method. *Multivariate Behavioral Research*, 17(3):301–341.
- Cohen, J., Cohen, P., West, S. G., and Aiken, L. S. (2003). *Applied multiple regression/correlation analysis for the behavioral sciences*. L. Erlbaum Associates, Mahwah, N.J., 3rd ed edition.
- Dawes, R. M. (1979). The robust beauty of improper linear models in decision making. *American Psychologist*, 34(7):571–582.
- Garcia, D. M., Schmitt, M. T., Branscombe, N. R., and Ellemers, N. (2010). Women’s reactions to ingroup members who protest discriminatory treatment: The importance of beliefs about inequality and response appropriateness. *European Journal of Social Psychology*, 40(5):733–745.
- Hayes, A. F. (2013). *Introduction to mediation, moderation, and conditional process analysis: A regression-based approach*. Guilford Press, New York.
- Hotelling, H. (1936). Relations between two sets of variates. *Biometrika*, 28(3/4):321–377.
- Kelley, K. (2017). *MBESS: The MBESS R Package*. R package version 4.4.1.
- Pollack, J. M., Vanepps, E. M., and Hayes, A. F. (2012). The moderating role of social ties on entrepreneurs’ depressed affect and withdrawal intentions in response to economic stress. *Journal of Organizational Behavior*, 33(6):789–810.
- Preacher, K. J. (2015). Advances in mediation analysis: A survey and synthesis of new developments. *Annual Review of Psychology*, 66:825–852.
- Preacher, K. J. and Hayes, A. F. (2004). SPSS and SAS procedures for estimating indirect effects in simple mediation models. *Behavior Research Methods, Instruments, & Computers*, 36(4):717–731.
- Preacher, K. J., Rucker, D. D., and Hayes, A. F. (2007). Addressing moderated mediation hypotheses: Theory, methods, and prescriptions. *Multivariate behavioral research*, 42(1):185–227.
- R Core Team (2023). *R: A Language and Environment for Statistical Computing*. R Foundation for Statistical Computing, Vienna, Austria.
- Revelle, W. (2023). *psych: Procedures for Personality and Psychological Research*. Northwestern University, Evanston, <https://CRAN.r-project.org/package=psych>. R package version 2.3.6
- Revelle, W. (in prep). *An introduction to psychometric theory with applications in R*. Springer.
- Rosseel, Y. (2012). lavaan: An R package for structural equation modeling. *Journal of Statistical Software*, 48(2):1–36.

Tal-Or, N., Cohen, J., Tsifti, Y., and Gunther, A. C. (2010). Testing causal direction in the influence of presumed media influence. *Communication Research*, 37(6):801–824.

Tingley, D., Yamamoto, T., Hirose, K., Keele, L., and Imai, K. (2014). mediation: R package for causal mediation analysis. *Journal of Statistical Software*, 59(5):1–38.

References

Cohen, J. (1982). Set correlation as a general multivariate data-analytic method. *Multivariate Behavioral Research*, 17(3):301–341.

Cohen, J., Cohen, P., West, S. G., and Aiken, L. S. (2003). *Applied multiple regression/correlation analysis for the behavioral sciences*. L. Erlbaum Associates, Mahwah, N.J., 3rd ed edition.

Dawes, R. M. (1979). The robust beauty of improper linear models in decision making. *American Psychologist*, 34(7):571–582.

Garcia, D. M., Schmitt, M. T., Branscombe, N. R., and Ellemers, N. (2010). Women’s reactions to ingroup members who protest discriminatory treatment: The importance of beliefs about inequality and response appropriateness. *European Journal of Social Psychology*, 40(5):733–745.

Hayes, A. F. (2013). *Introduction to mediation, moderation, and conditional process analysis: A regression-based approach*. Guilford Press, New York.

Hotelling, H. (1936). Relations between two sets of variates. *Biometrika*, 28(3/4):321–377.

Kelley, K. (2017). *MBESS: The MBESS R Package*. R package version 4.4.1.

Pollack, J. M., Vanepps, E. M., and Hayes, A. F. (2012). The moderating role of social ties on entrepreneurs’ depressed affect and withdrawal intentions in response to economic stress. *Journal of Organizational Behavior*, 33(6):789–810.

Preacher, K. J. (2015). Advances in mediation analysis: A survey and synthesis of new developments. *Annual Review of Psychology*, 66:825–852.

Preacher, K. J. and Hayes, A. F. (2004). SPSS and SAS procedures for estimating indirect effects in simple mediation models. *Behavior Research Methods, Instruments, & Computers*, 36(4):717–731.

Preacher, K. J., Rucker, D. D., and Hayes, A. F. (2007). Addressing moderated mediation hypotheses: Theory, methods, and prescriptions. *Multivariate behavioral research*, 42(1):185–227.

R Core Team (2023). *R: A Language and Environment for Statistical Computing*. R Foundation for Statistical Computing, Vienna, Austria.

- Keon-Woong Moon (2020). *processR: Implementation of the 'PROCESS' Macro*. <https://CRAN.R-project.org/package=processR>
- Revelle, W. (2023). *psych: Procedures for Personality and Psychological Research*. Northwestern University, Evanston, <https://CRAN.r-project.org/package=psych>. R package version 2.3.5
- Revelle, W. (in prep). *An introduction to psychometric theory with applications in R*. Springer.
- Rosseel, Y. (2012). lavaan: An R package for structural equation modeling. *Journal of Statistical Software*, 48(2):1–36.
- Tabacnik, B.G and Fidell, L.S. (2001) Using multivariate statistics. Allyn and Bacon.
- Tal-Or, N., Cohen, J., Tsfati, Y., and Gunther, A. C. (2010). Testing causal direction in the influence of presumed media influence. *Communication Research*, 37(6):801–824.
- Tingley, D., Yamamoto, T., Hirose, K., Keele, L., and Imai, K. (2014). mediation: R package for causal mediation analysis. *Journal of Statistical Software*, 59(5):1–38.